

ACURA

Dealership Identification Program & Branding Guidelines



410 N. Cedar Bluff Road Suite 101
Knoxville, Tennessee 37923
www.pattisonsign.com

ACURA Sign Family



Directionals & Pre-Owned

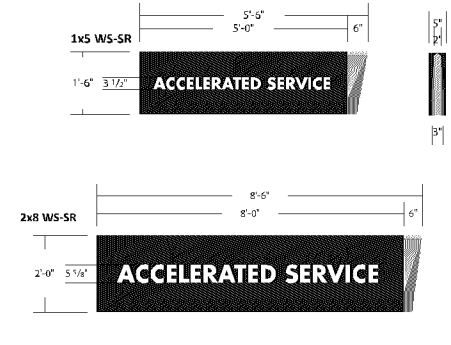

Illuminated Wall Signs

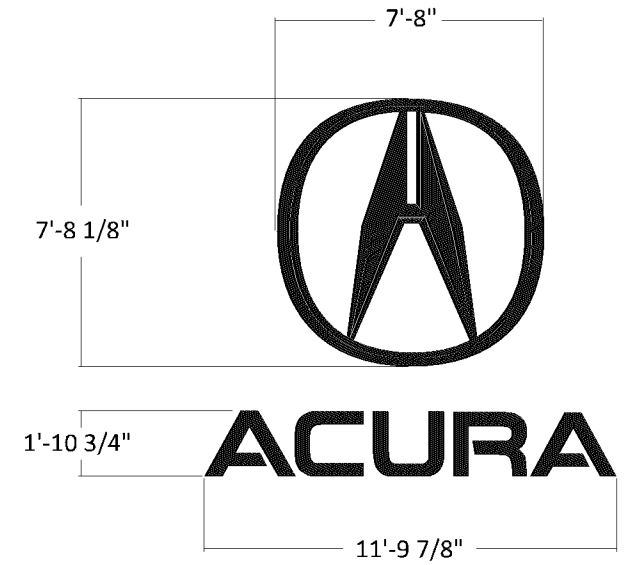

Illuminated Dealership Entrance Icon & Letters
(130 sq.ft.)

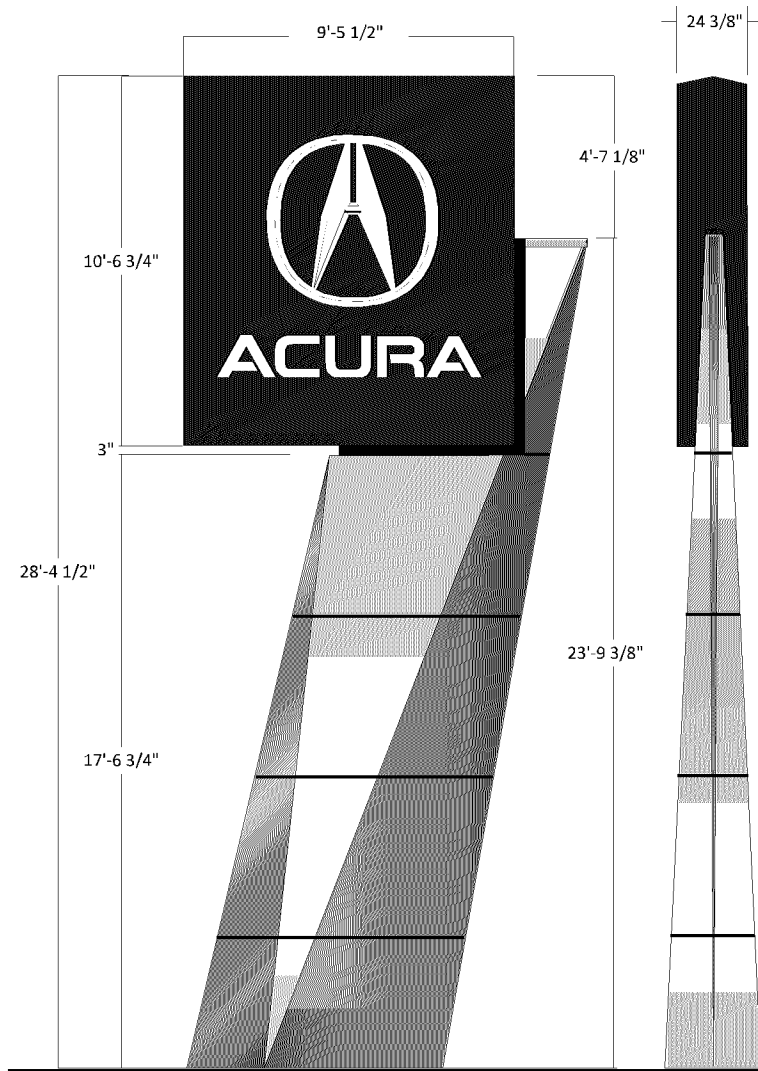

100 Sq Ft Pylon

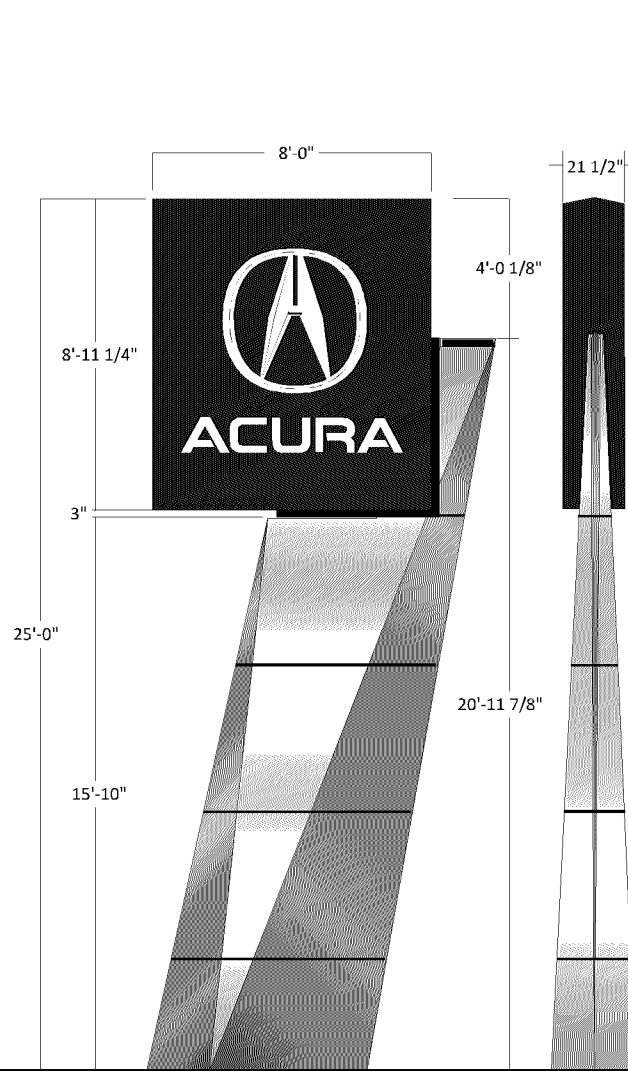

75 Sq Ft Pylon

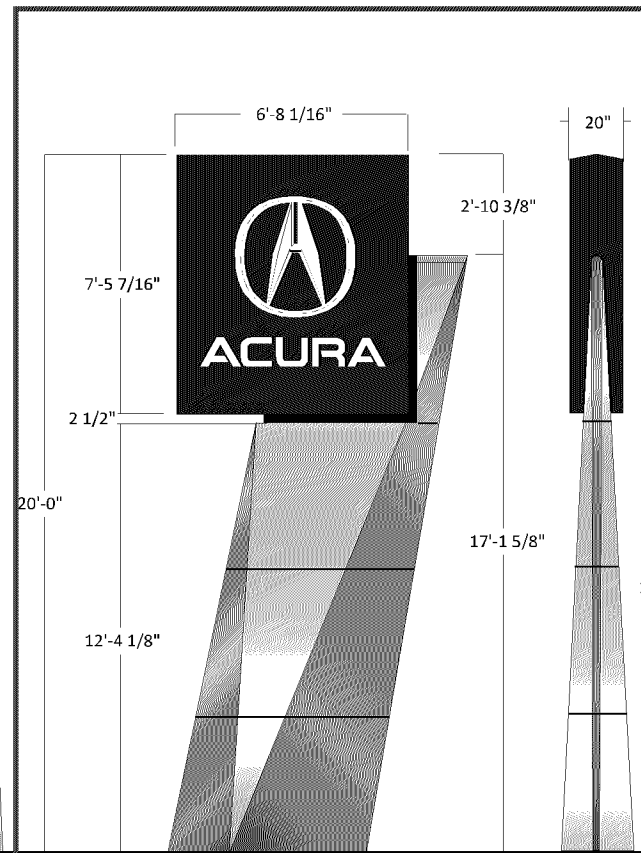

50 Sq Ft Pylon

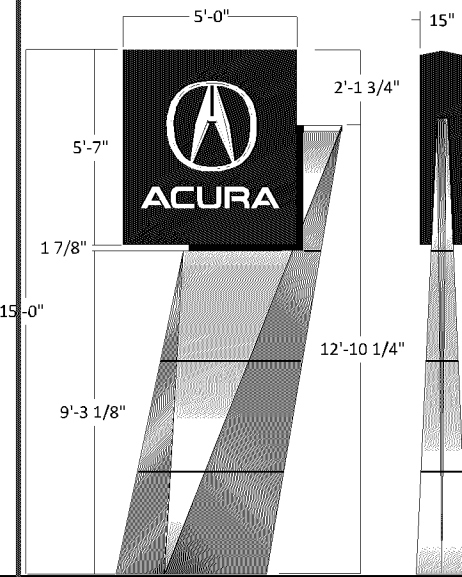

30 Sq Ft Pylon

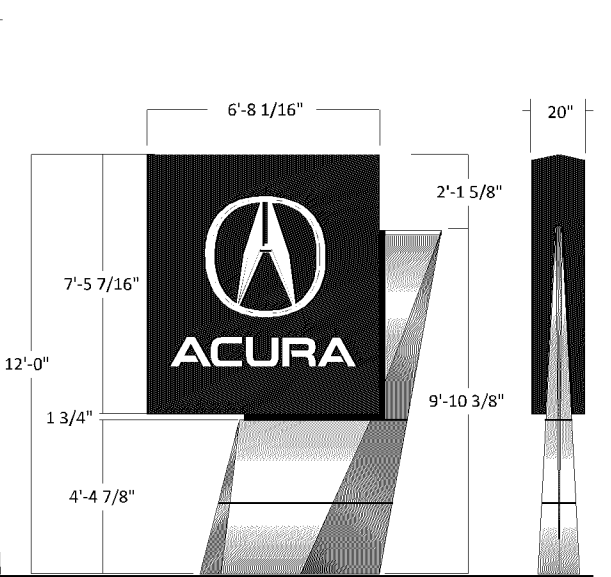

50 Sq Ft Monument

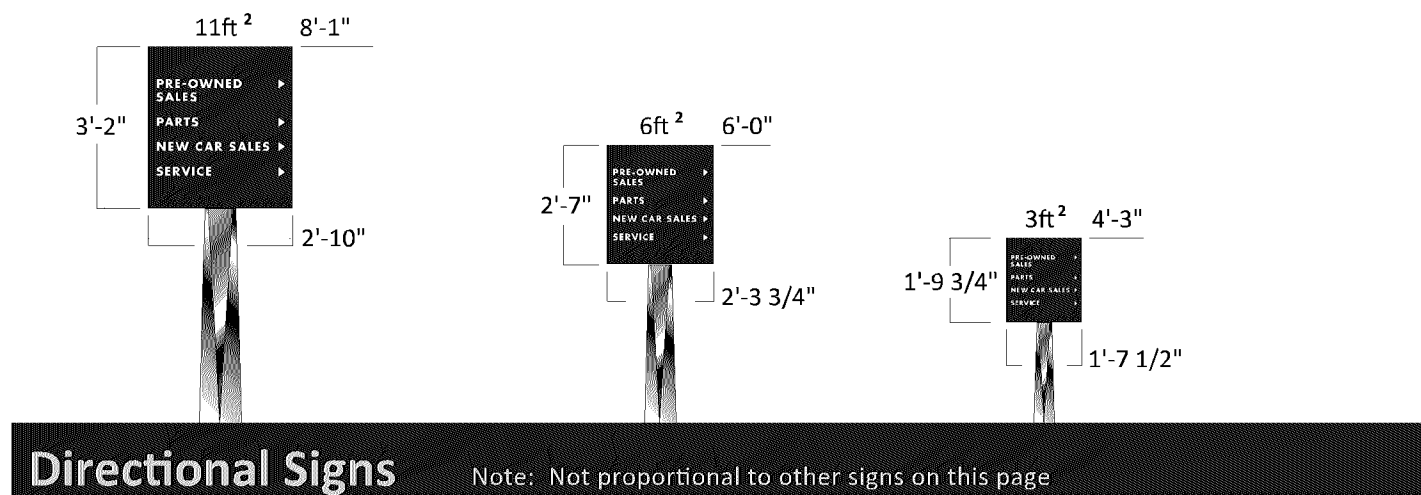
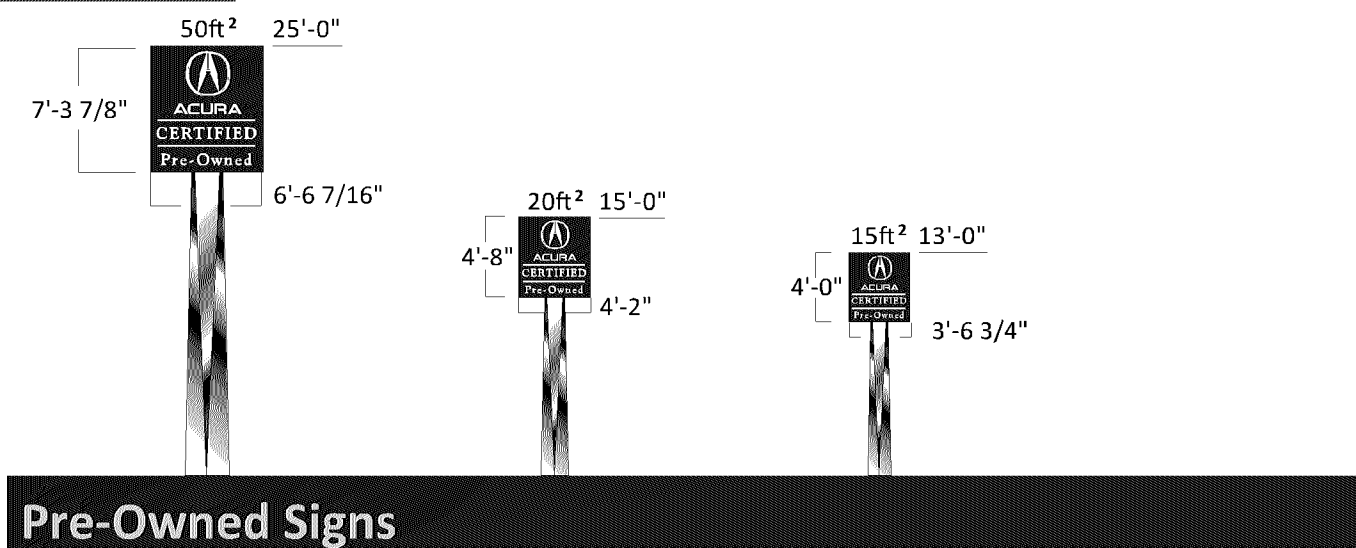
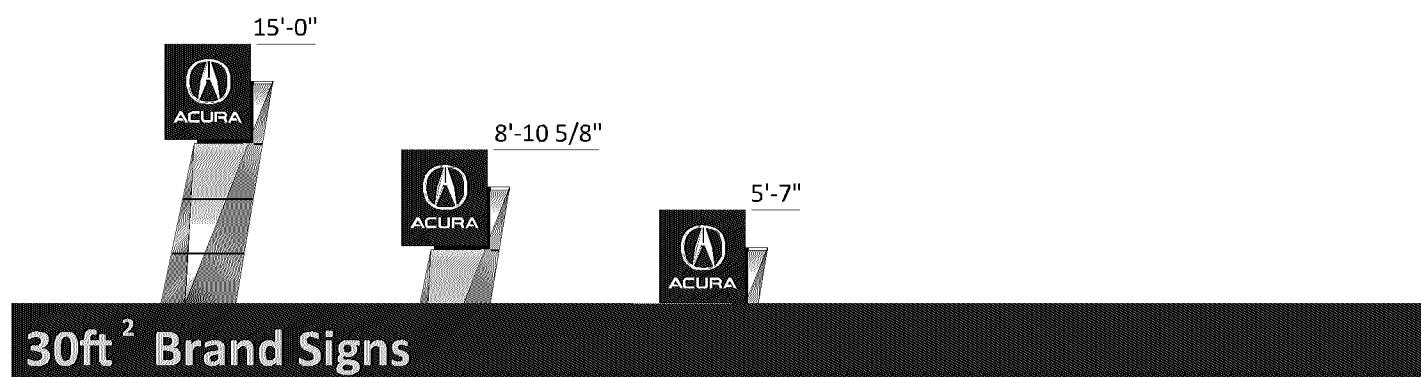
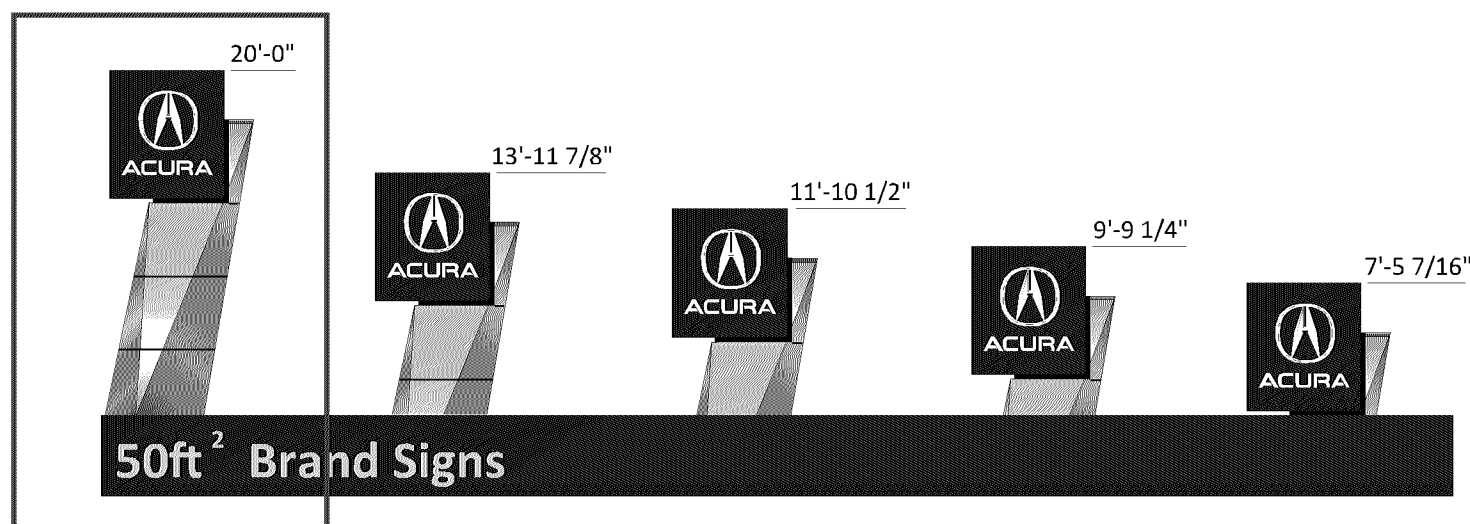
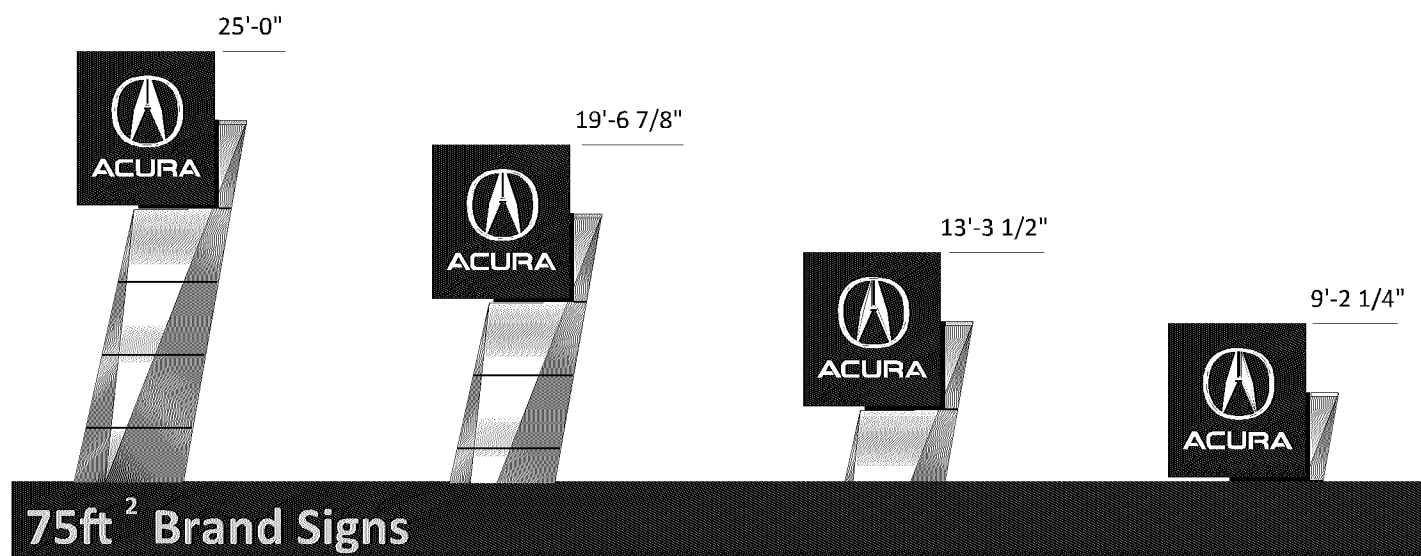
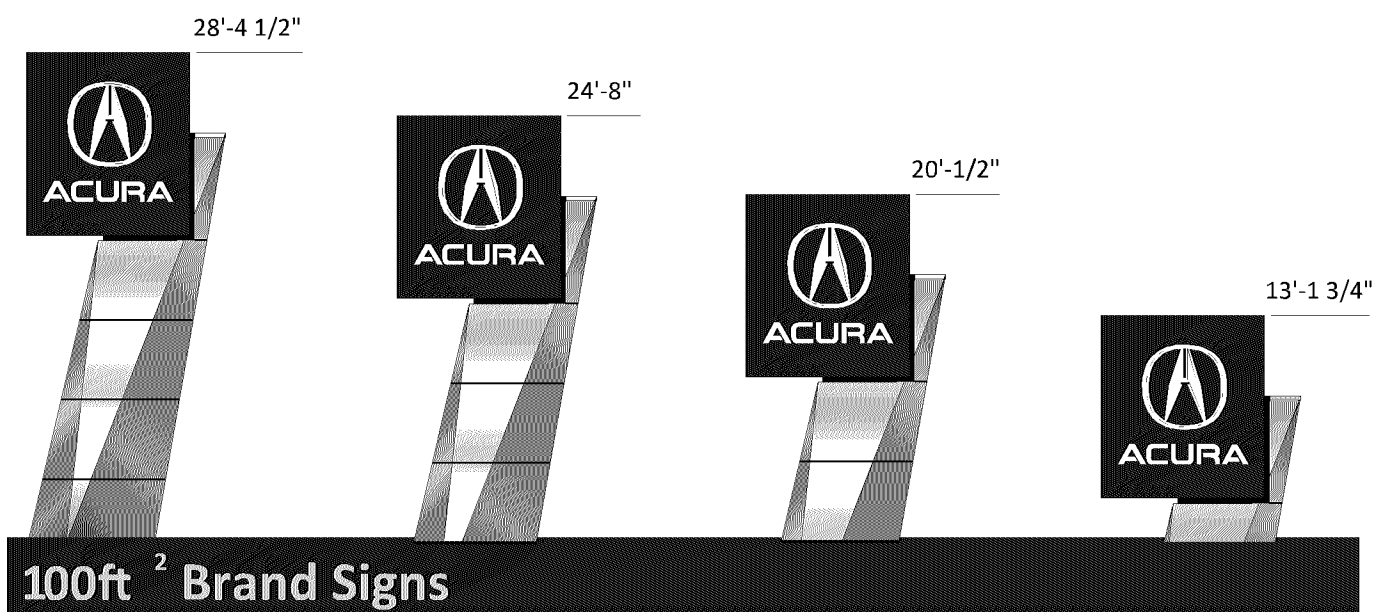

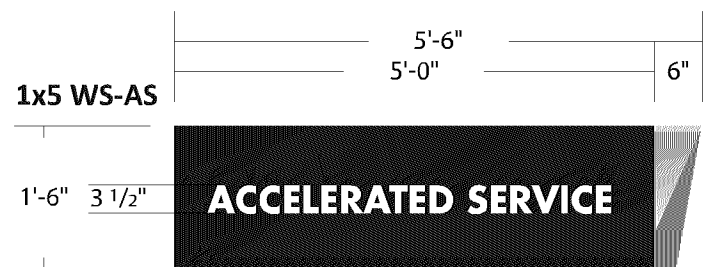

1x5 Acura S/F Illuminated Wall Sign - Routed Out and Pushed Through

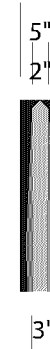
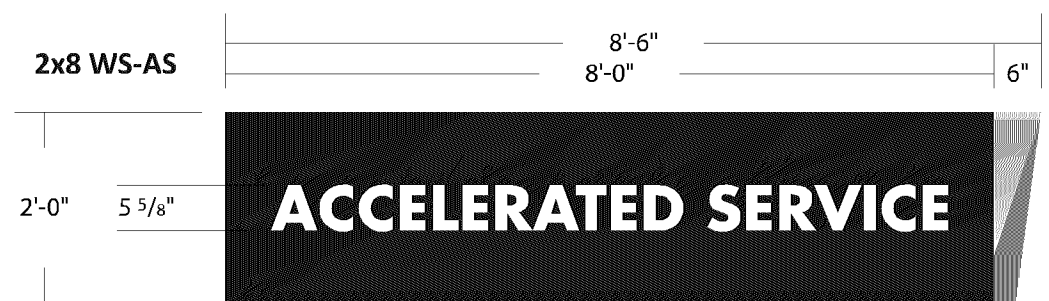

2x8 Acura S/F Illuminated Wall Sign - Routed Out and Pushed Through

Acura Branding Guidelines

Acura logo and ACURA letterset on tower are illuminated.

Acura logo placement as per Pattison Sign Group install drawing.

Available Trademark "ACURA" letters on secondary elevations are 24" or 18".

Standard DEALER NAME letters are 18" upper case. LED illuminated.
The faces are striped so they are blue by day and white at night.
The dealer name letterset is a minimum of 3' from the edge of the elevation.
Installed 12" above building cap.

The dealer name follows DBA guidelines

"SERVICE" letters are 18" all upper case with elongated letter spacing. LED illuminated.
The faces are striped so they are blue by day and white at night.
Installed center above service bay door(s).

"PRE-OWNED" letters are 18' upper case. LED illuminated.

The Acura Brand sign is 100sf @ 28'. If not permitted by City code, various sizes are available.

The face of the Acura Brand sign faces the street where the "wing" faces back toward the dealership.

Non-illuminated directional signs are cladded and direct burial.

Acura Certified Pre-Owned ground signs are LED illuminated.

All sign elements need to be approved by Interbrand Design Forum and AHM.

Standard Sign Placement

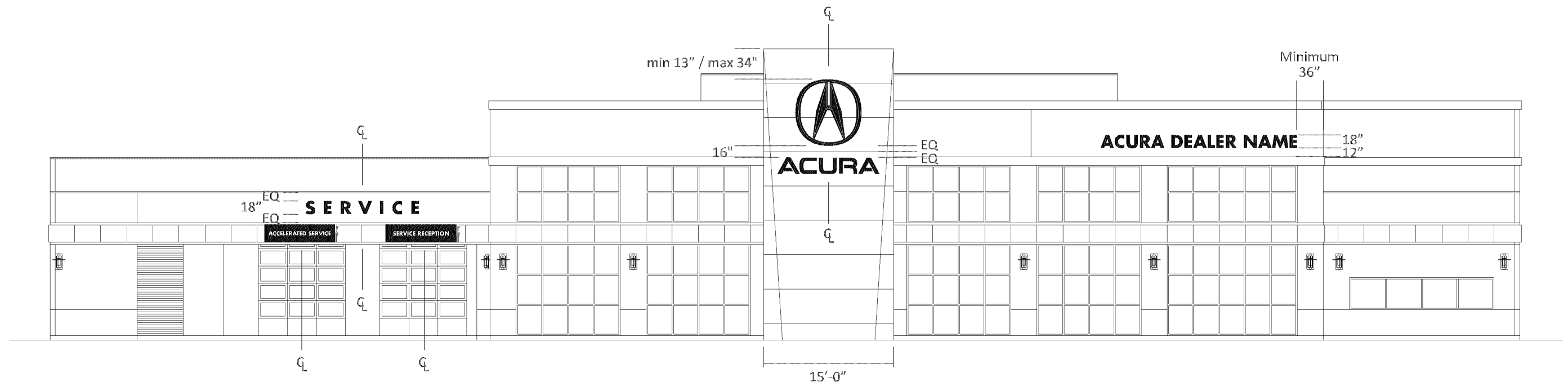

PERFECT

Non-Standard

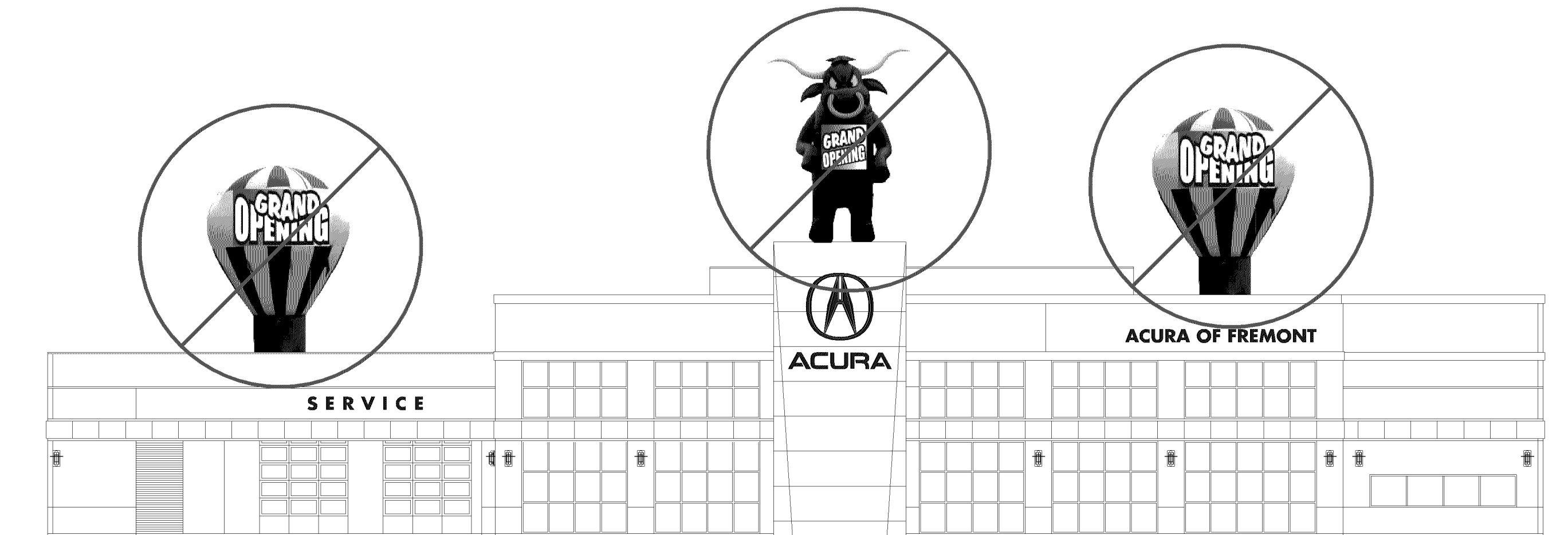

This is not under AHM authority, but wishes that it was!

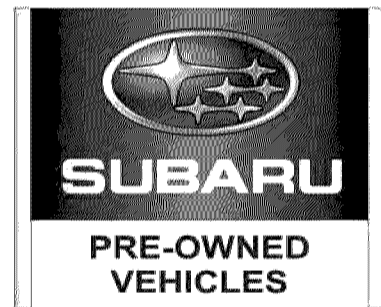

P48
6' 2" H X 7' 7"
X 16' 4" OAH

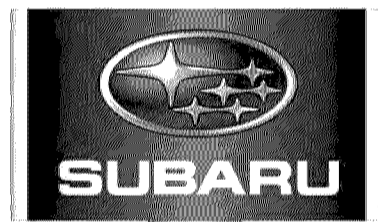

P30
4' 4" H X 7' 7"
X 15' 3" OAH

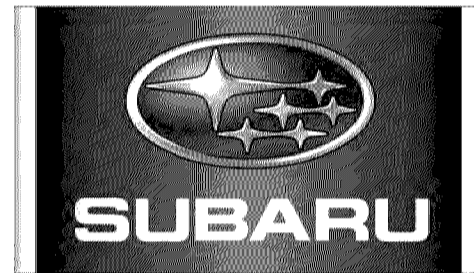

P50
5' 7" H X 9' 9"
X 20' 3" OAH

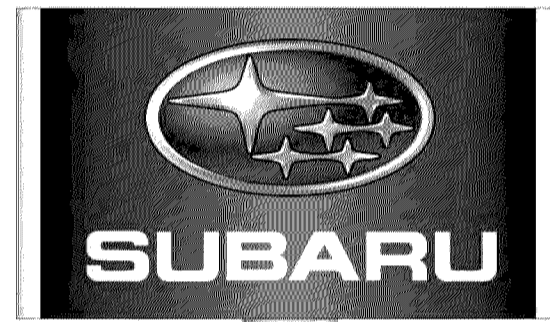

P65
6' 4" H X 11' 2"
X 21' 0" OAH

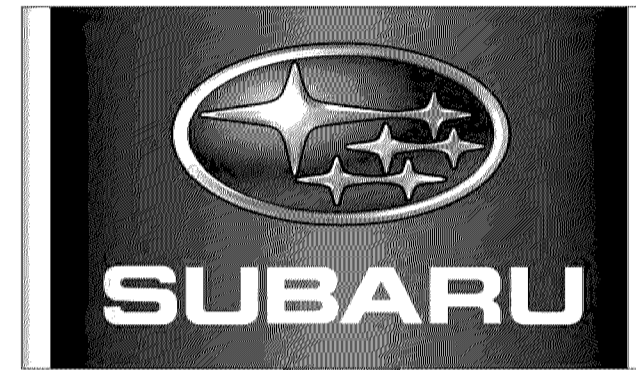

P90
7' 6" H X 13' 1"
X 25' 9" OAH

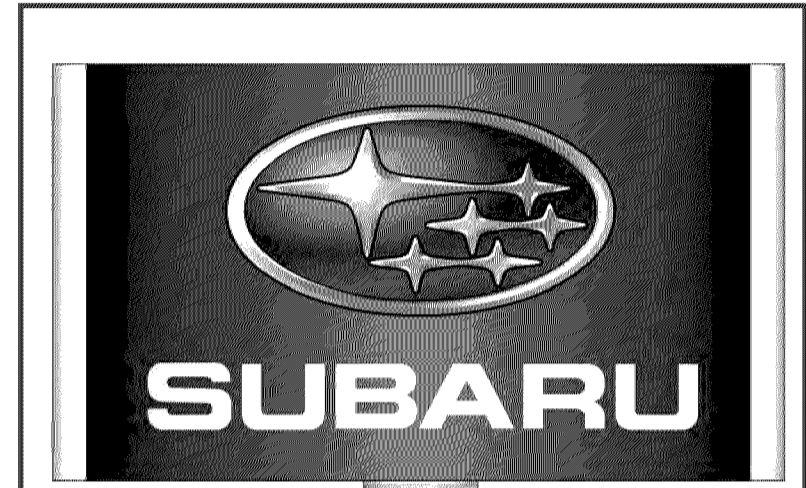

P120
8' 8" H X 15' 2"
X 26' 11" OAH

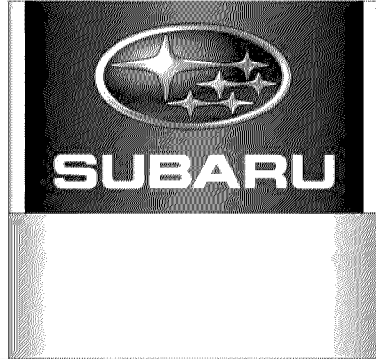

M30
4' 4" H X 7' 10"
X 6' 10" OAH

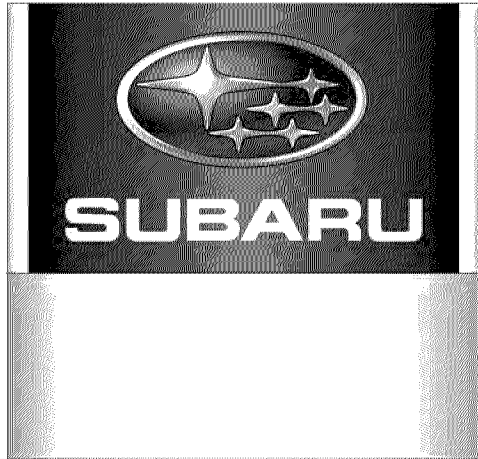

M50
5' 7-1/2" H X 9' 11"
X 8' 1-1/2" OAH

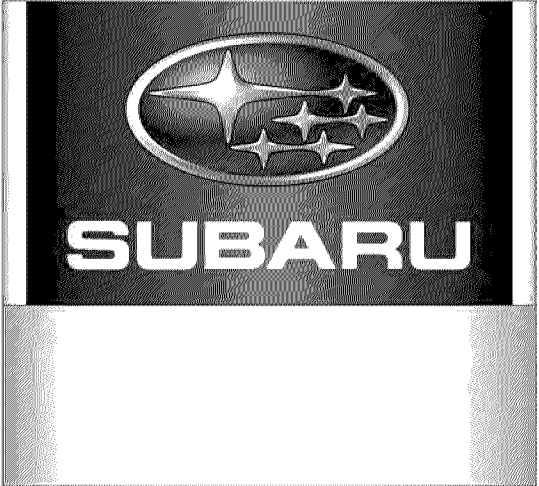

M65
6' 4" H X 11' 1"
X 8' 10" OAH

30" DIRECTIONAL

DIRECTIONAL SIGN 19"H X 30"W
 SINGLE OR DOUBLE SIDED W/ TWIN POLES AND
 WHITE REFLECTIVE GRAPHICS.
 OPTION FOR INTERNALLY ILLUMINATED WITH LIT
 WHITE ACRYLIC GRAPHICS.
 SAMPLE COPY SHOWN; TO VARY PER
 DAELER'S NEEDS

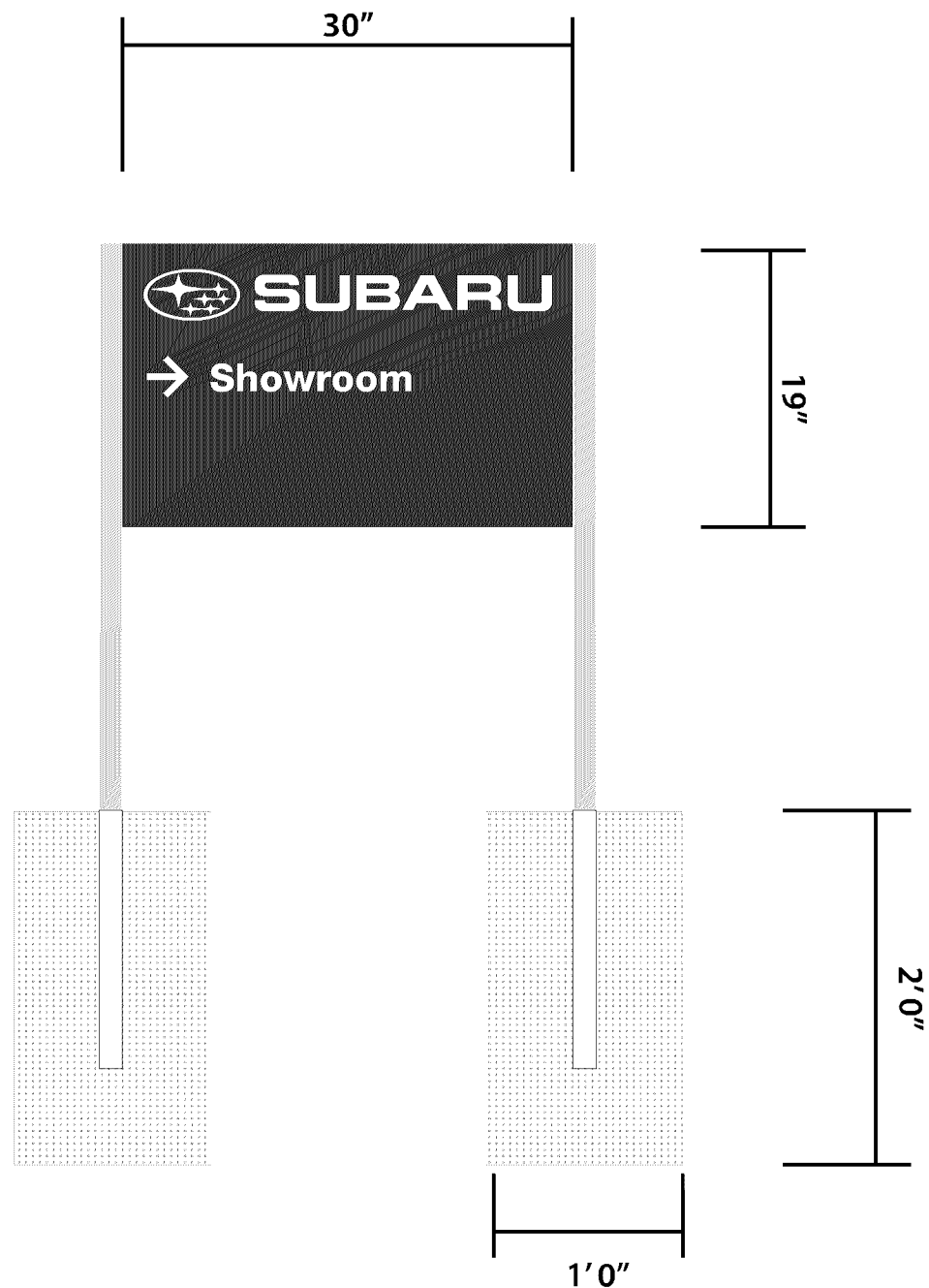

Side A



Side B

TITLE	Subaru	DWG BY	AFR	DATE	12.17.14
ADDRESS	SUB_Regulatories Samples	DWG NUM	B58649	DATE	REVISION
		SHEET	1		

BY

THIS IS AN ORIGINAL UNPUBLISHED DRAWING CREATED BY P.S.C.O. IT IS SUBMITTED FOR YOUR PERSONAL USE IN CONJUNCTION WITH A PROJECT BEING PLANNED FOR YOU BY P.S.C.O. IT IS NOT TO BE SHOWN TO ANYONE OUTSIDE YOUR ORGANIZATION NOR IS IT TO BE USED, COPIED, REPRODUCED, OR EXHIBITED IN ANY FASHION.

36" DIRECTIONAL

DIRECTIONAL SIGN 24"H X 36"W
 SINGLE OR DOUBLE SIDED W/ TWIN POLES AND
 WHITE REFLECTIVE GRAPHICS.
 OPTION FOR INTERNALLY ILLUMINATED WITH LIT
 WHITE ACRYLIC GRAPHICS.
 SAMPLE COPY SHOWN; TO VARY PER
 DAELER'S NEEDS

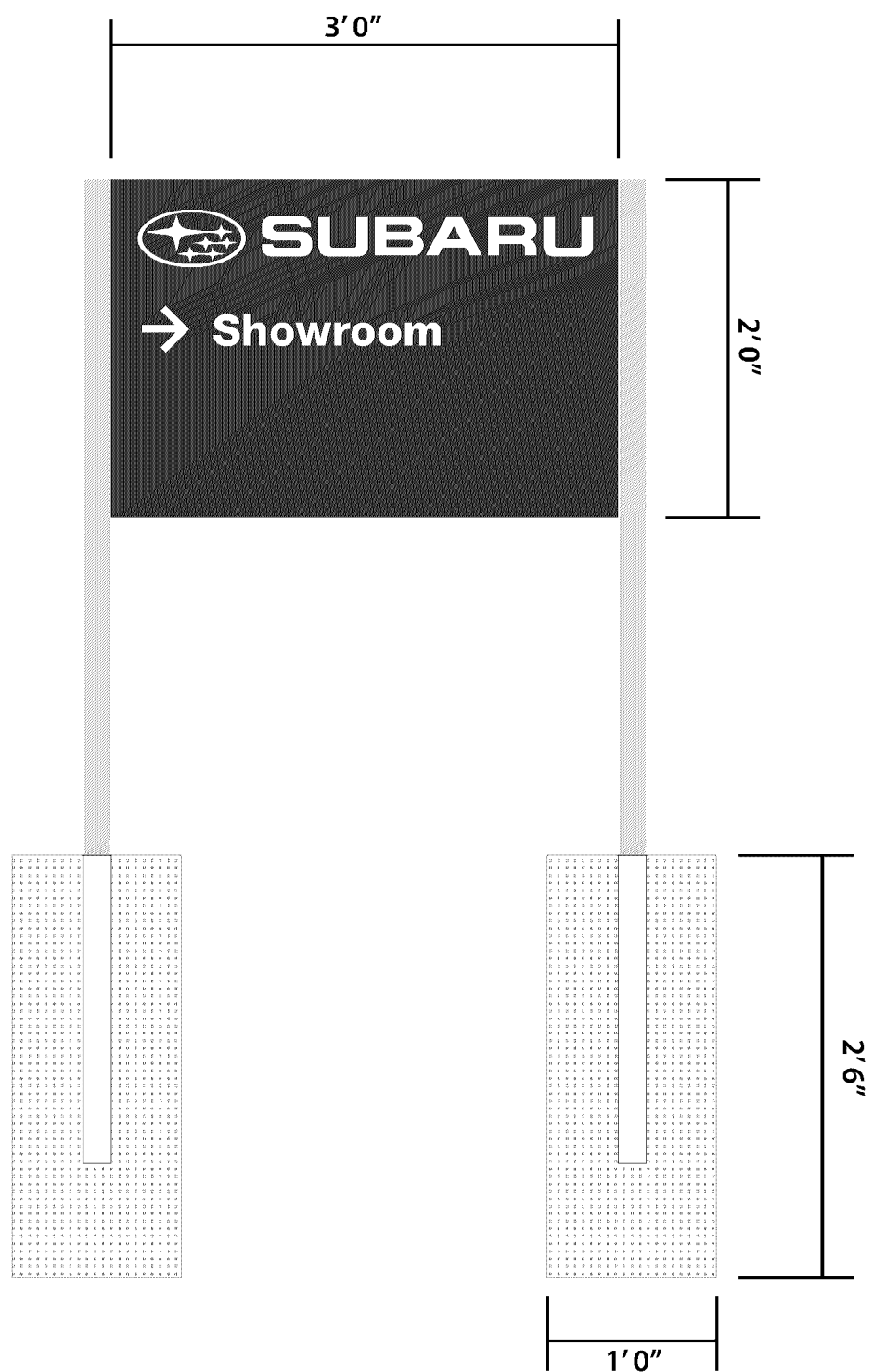

Side A



Side B



TITLE	Subaru	DWG BY	AFR	DATE	12.17.14
ADDRESS	SUB_Regulatories Samples	DWG NUM	B58649	DATE	REVISION
		SHEET	2		

BY

THIS IS AN ORIGINAL UNPUBLISHED DRAWING CREATED BY P.S.C.O. IT IS SUBMITTED FOR YOUR PERSONAL USE IN CONJUNCTION WITH A PROJECT BEING PLANNED FOR YOU BY P.S.C.O. IT IS NOT TO BE SHOWN TO ANYONE OUTSIDE YOUR ORGANIZATION NOR IS IT TO BE USED, COPIED, REPRODUCED, OR EXHIBITED IN ANY FASHION.

48" DIRECTIONAL

DIRECTIONAL SIGN 2' 4-1/2"H X 4' 0"W
 SINGLE OR DOUBLE SIDED W/ TWIN POLES AND
 WHITE REFLECTIVE GRAPHICS.
 OPTION FOR INTERNALLY ILLUMINATED WITH LIT
 WHITE ACRYLIC GRAPHICS.
 SAMPLE COPY SHOWN; TO VARY PER
 DAELER'S NEEDS

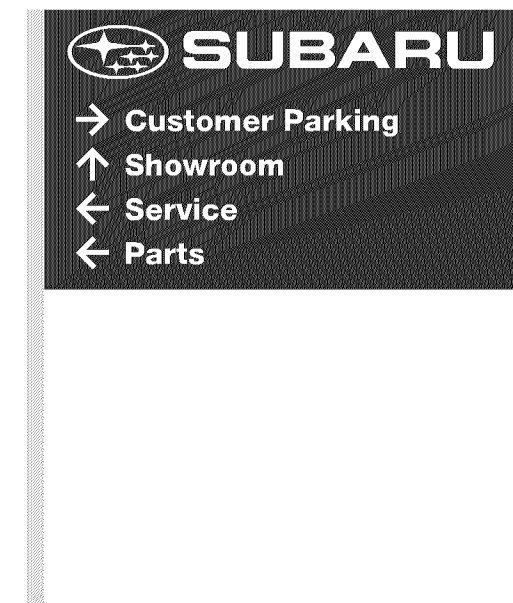
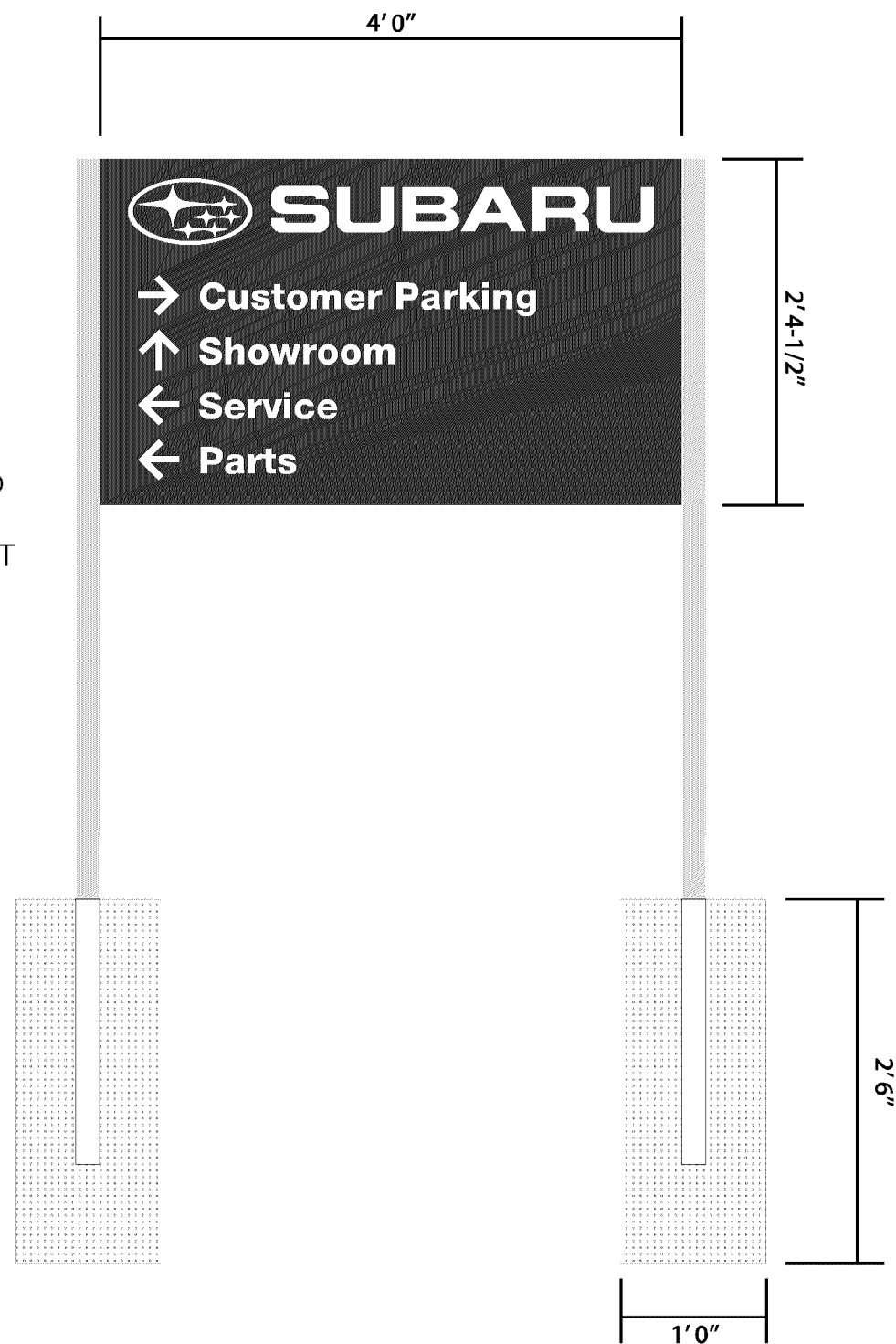

Side A

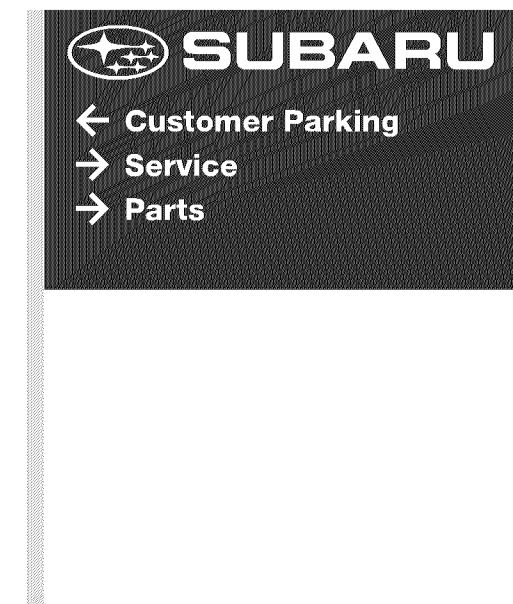

Side B



TITLE	Subaru	DWG BY	AFR	DATE	12.17.14
ADDRESS	SUB_Regulatories Samples	DWG NUM	B58649	DATE	REVISION
		SHEET	3		

BY THIS IS AN ORIGINAL UNPUBLISHED DRAWING CREATED BY P.S.C.O. IT IS SUBMITTED FOR YOUR PERSONAL USE IN CONJUNCTION WITH A PROJECT BEING PLANNED FOR YOU BY P.S.C.O. IT IS NOT TO BE SHOWN TO ANYONE OUTSIDE YOUR ORGANIZATION NOR IS IT TO BE USED, COPIED, REPRODUCED, OR EXHIBITED IN ANY FASHION.

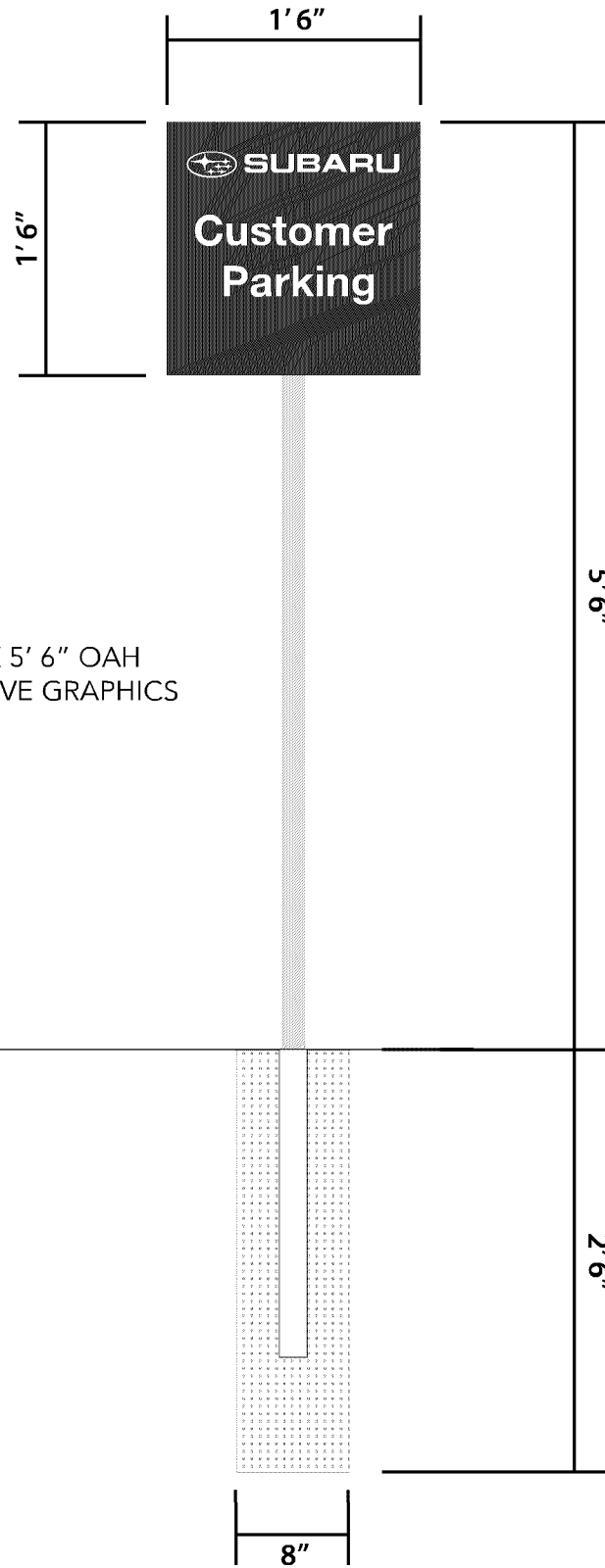

INFO BLADE SIGN SIGN 18" H X 18" W X 5' 6" OAH
 POLE MOUNTED WITH WHITE REFLECTIVE GRAPHICS
 SAMPE COPY: CUSTOMER PARKING

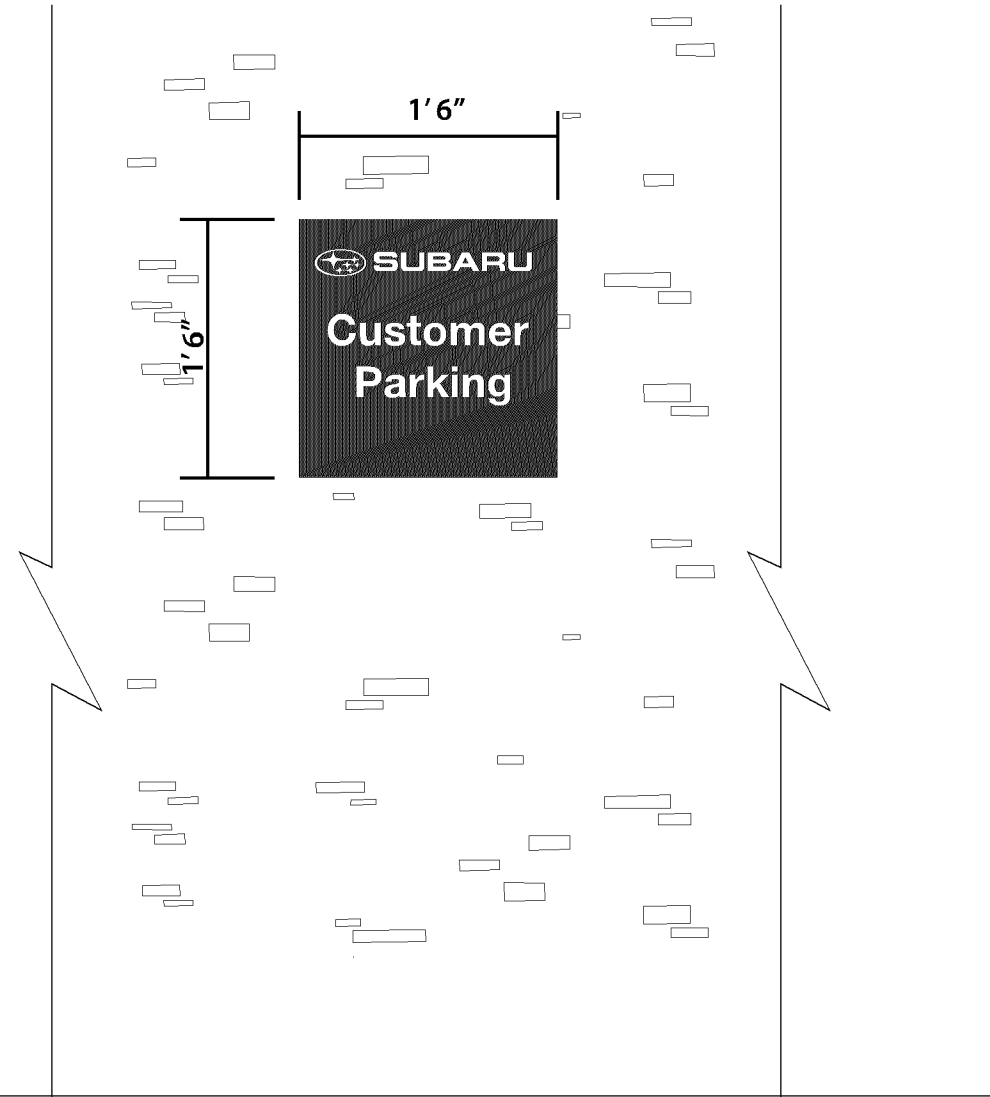

INFO WALL PLAQUE SIGN 18" H X 18"
 WALL MOUNTED WITH WHITE REFLECTIVE GRAPHICS
 SAMPE COPY: CUSTOMER PARKING

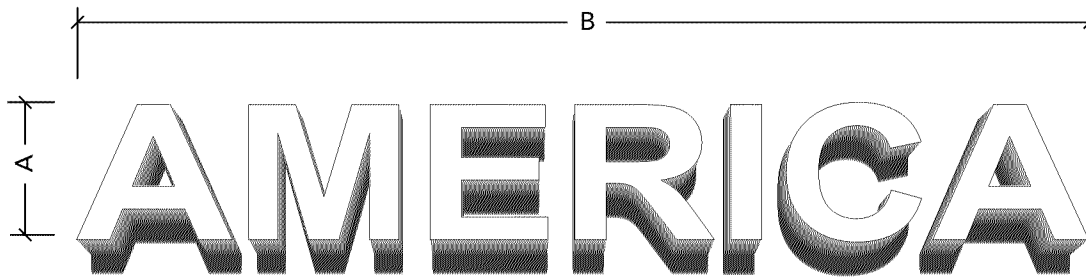

Night Channel Letter Elevation

Scale: NTS

Night Channel Letter Specifications

#2447 White Acrylic w/Perforated 3M Vinyl VDN-10968 3630-137 European Blue/210 White Vinyl Dual Color Film Laminated to Face (Blue By Day, White By Night)

White Precoat Returns Painted Matthews 281342SP Brushed Aluminum

1" Wide Chrome Jewelite

White LED Lit

Raceway to match building fascia

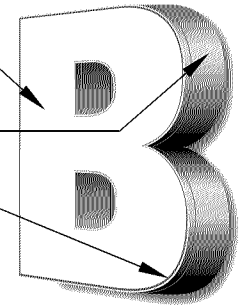

Color Schedule

Letter Faces	3M Vinyl VDN-10968 3630-137 European Blue/210 White Vinyl Dual Color Film Laminated to Face (Day=Blue/Night=White)
Trimcap	Chrome Jewelite
Returns	Matthews 281342SP Brushed Alum.
Raceway	Painted to match fascia

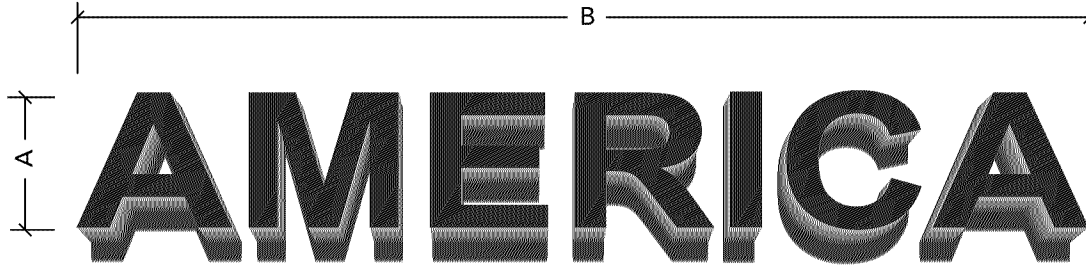

Day Channel Letter Elevation

Scale: NTS

Day Channel Letter Specifications

#2447 White Acrylic w/Perforated 3M Vinyl VDN-10968 3630-137 European Blue/210 White Vinyl Dual Color Film Laminated to Face (Blue By Day, White By Night)

White Precoat Returns Painted Matthews 281342SP Brushed Aluminum

1" Wide Chrome Jewelite

White LED Lit

Raceway to match building fascia

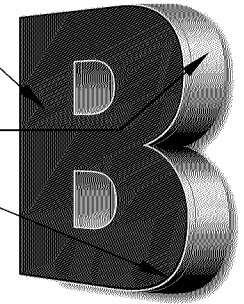

Color Schedule

Letter Faces	3M Vinyl VDN-10968 3630-137 European Blue/210 White Vinyl Dual Color Film Laminated to Face (Day=Blue/Night=White)
Trimcap	Chrome Jewelite
Returns	Matthews 281342SP Brushed Alum.
Raceway	Painted to match fascia

Sign Type	A	B	Sq Ft	Face
12" America	12"	7' 3"	7.25	Acrylic
18" America	18"	10' 10-3/8"	16.3	Acrylic
24" America	24"	14' 5-7/8"	28.98	Acrylic
36" America	36"	18' 11-1/2"	56.86	Acrylic

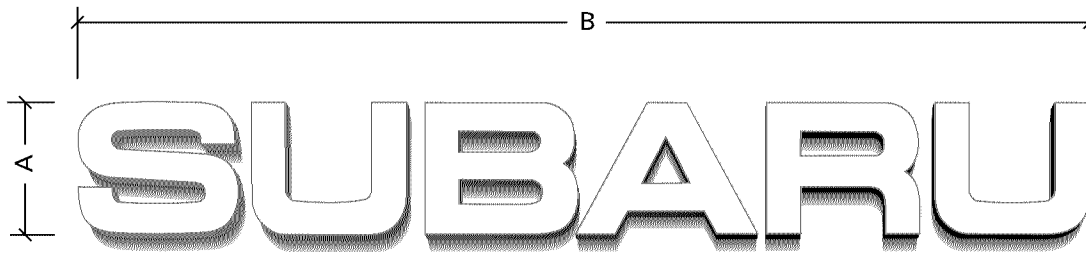

Night Channel Letter Elevation

Scale: NTS

Night Channel Letter Specifications

#2447 White Acrylic w/Perforated 3M Vinyl VDN-10968 3630-137 European Blue/210 White Vinyl Dual Color Film Laminated to Face (Blue By Day, White By Night)

White Precoat Returns Painted Matthews 281342SP Brushed Aluminum

1" Wide Chrome Jewelite

15mm 6500 White Neon Tubes

60ma 120 volt Transformer

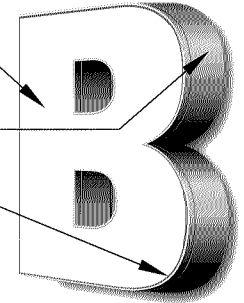

Color Schedule

Letter Faces	3M Vinyl VDN-10968 3630-137 European Blue/210 White Vinyl Dual Color Film Laminated to Face (Day=Blue/Night=White)
Trimcap	Chrome Jewelite
Returns	Matthews 281342SP Brushed Alum.

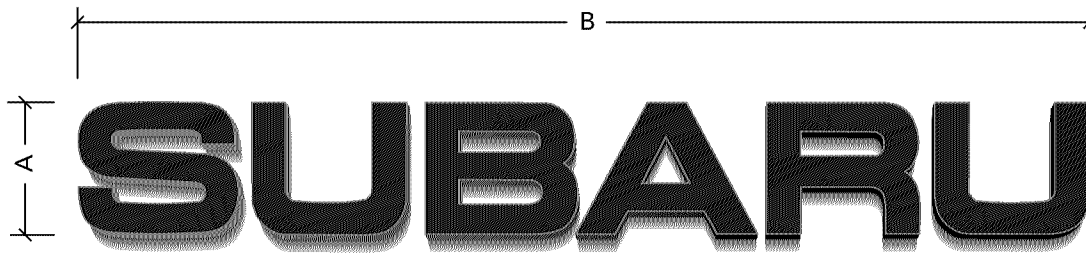

Day Channel Letter Elevation

Scale: NTS

Day Channel Letter Specifications

#2447 White Acrylic w/Perforated 3M Vinyl VDN-10968 3630-137 European Blue/210 White Vinyl Dual Color Film Laminated to Face (Blue By Day, White By Night)

White Precoat Returns Painted Matthews 281342SP Brushed Aluminum

1" Wide Chrome Jewelite

15mm 6500 White Neon Tubes

60ma 120 volt Transformer

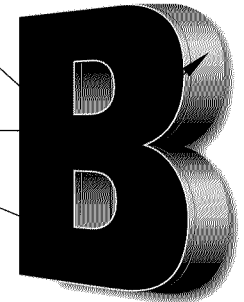

Color Schedule

Letter Faces	3M Vinyl VDN-10968 3630-137 European Blue/210 White Vinyl Dual Color Film Laminated to Face (Day=Blue/Night=White)
Trimcap	Chrome Jewelite
Returns	Matthews 281342SP Brushed Alum.

Sign Type	A	B	Sq Ft	Face
CLB.18_SUB	18"	12' 10"	19.25	Acrylic
CLB.24_SUB	24"	17' 1-1/4"	34.21	Acrylic
CLB.36_SUB	36"	25' 7-3/4"	76.94	Acrylic



CUSTOMER:

SUBARU

JOB NUMBER:

SUB_CL ILL_15383

SIGN TYPE:

LOGO.CHR.36_SUB_LED

LOCATION:

DATE:

11-17-15

DRAWN BY:

RAB

REVISION:

Number: Date: By:

SHEET:

1 of 1

DWG NUMBER:

B65429

ENGINEER SEAL:

MAX DESIGN WIND SPEED 90 MPH
EXPOSURE C

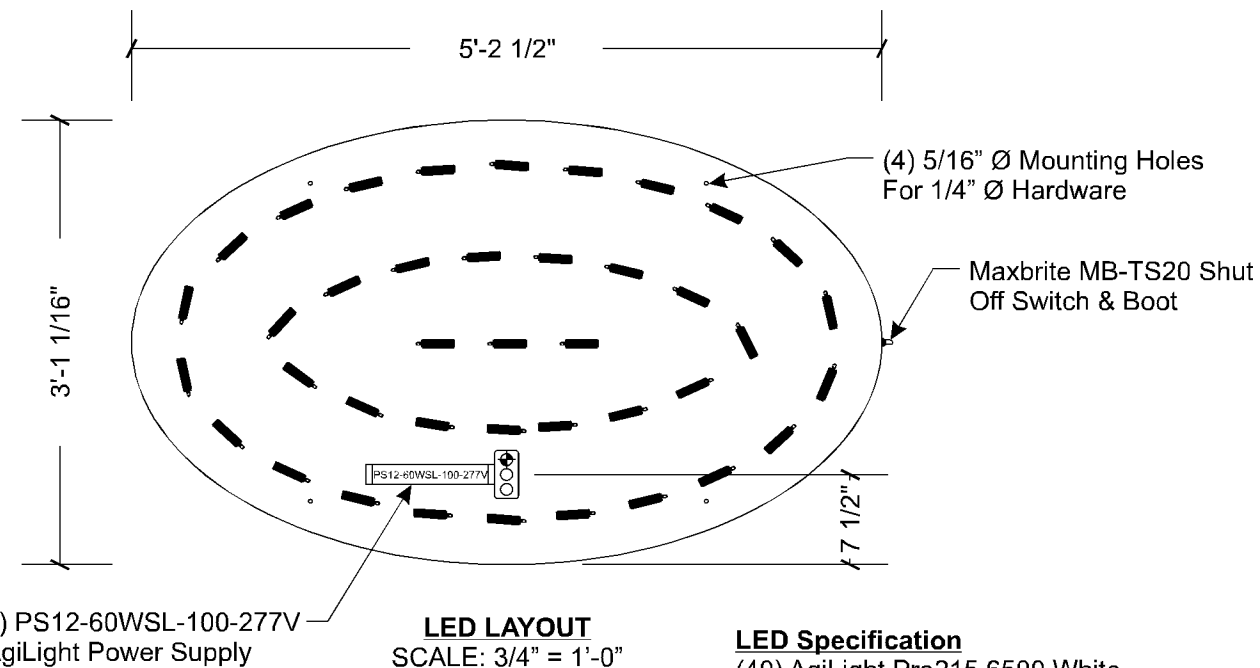
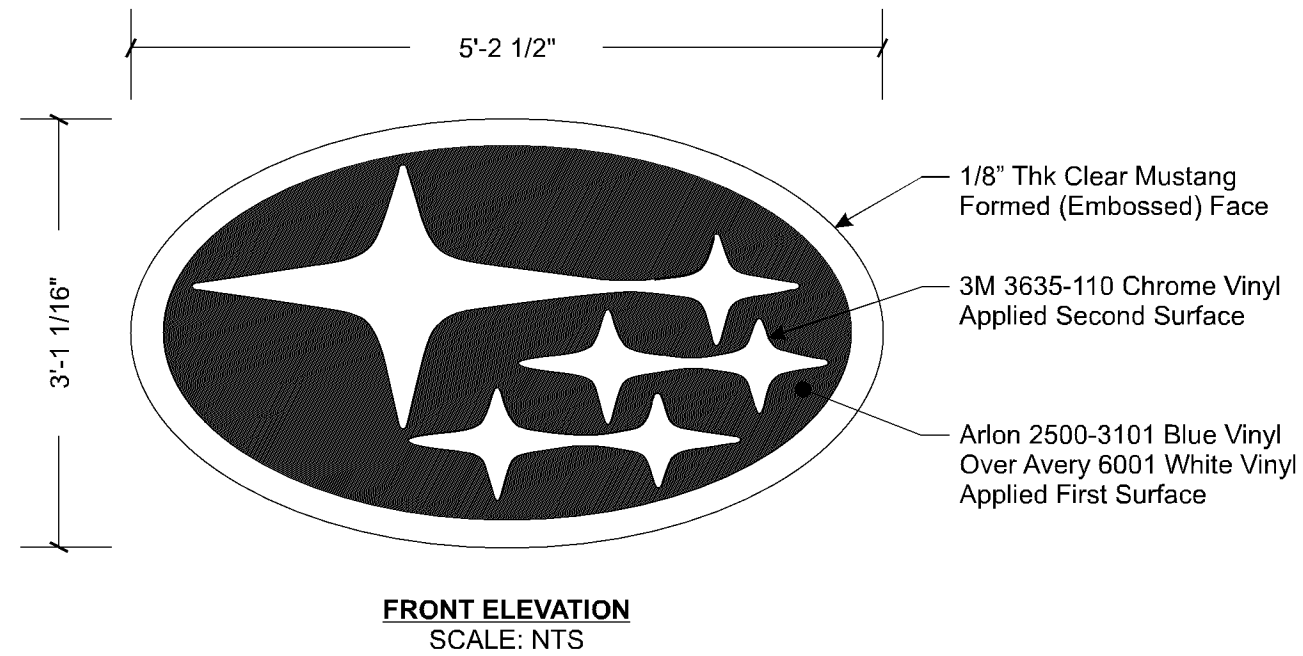

LED Specification

(40) AgiLight Pro215 6500 White LED's (LS-PRO-215-65K-2G3)

(1) Agilight 60 Watt Power Supply (PS12-60WSL-100-277V)

Each 60 Watt Power Supply Will Run a Maximum of 50 Modules

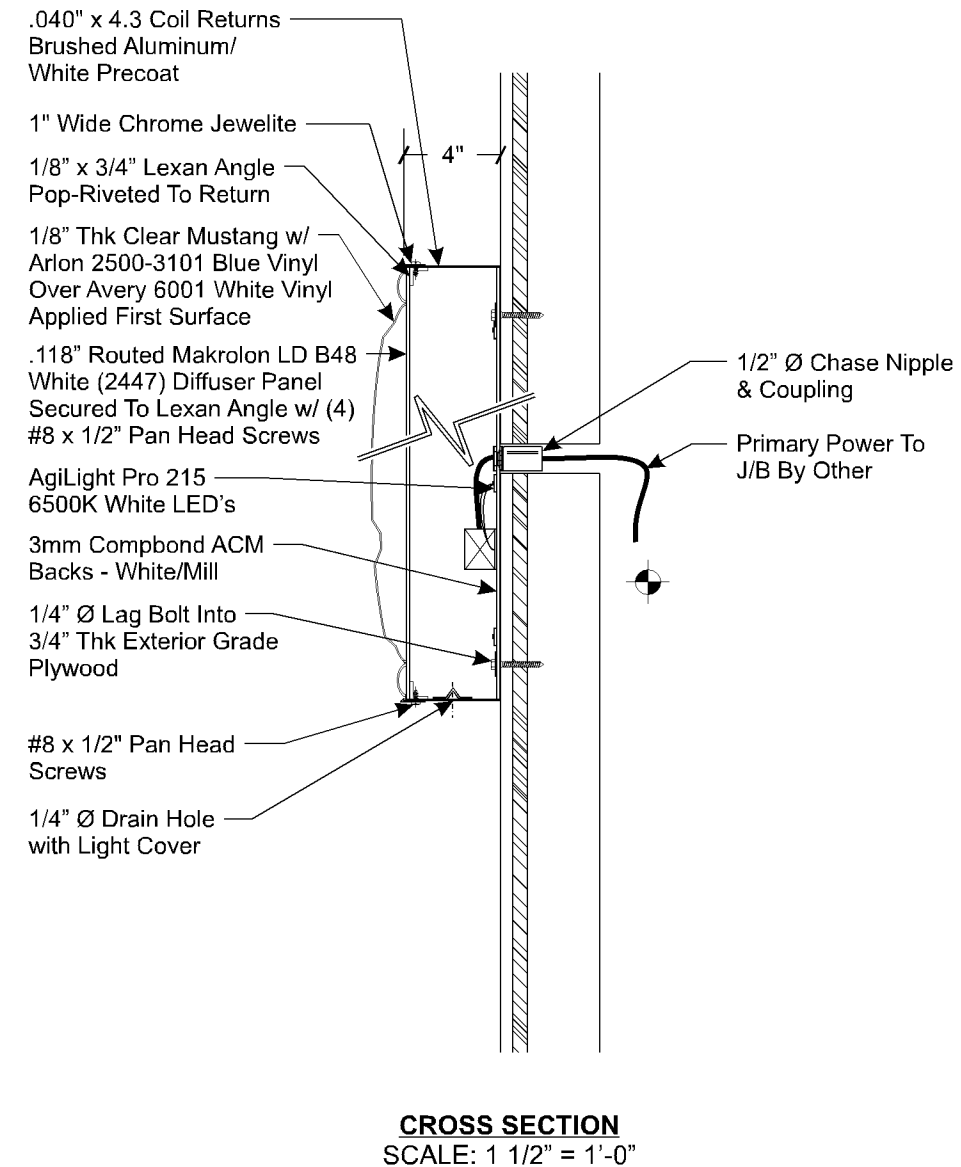

Electrical Load
0.63 Amps @ 120 Volts
Electrical Req'mts
(1) 20 Amp/120 Volt Circuits

STANDARD WALL SIGN NOTES:

1. Sufficient Primary Circuit In Vicinity Of Sign By Others.
2. Final Primary Hook-up By Sign Installer, Where Allowed By Local Codes.
3. Sign Shall Be U.L. Listed.
4. Mounting Hardware By Sign Installer.

Note: This sign is intended to be installed in accordance with the requirements of Article 600 of the National Electrical Code and/or other applicable local codes. This includes proper grounding and bonding of the sign.

THIS IS AN ORIGINAL UNPUBLISHED DRAWING CREATED BY PSC0. IT IS SUBMITTED FOR YOUR PERSONAL USE IN CONJUNCTION WITH A PROJECT BEING PLANNED FOR YOU BY PSC0. IT IS NOT TO BE SHOWN TO ANYONE OUTSIDE YOUR ORGANIZATION NOR IS IT TO BE USED, COPIED, REPRODUCED, OR EXHIBITED IN ANY FASHION.